

Tiltrotator EC214

Suitable for all excavators in the 9–14 tonne weight class

A compact, powerful tiltrotator with low weight and height for excavators up to 14 tons. If the EC214 is selected with engcon's standard quick hitch S45 or S60 and the DC2 proportional control system, EC-Oil is offered an automatic quick hitch system as a free standard** This means that the tiltrotator and hydraulic tools can be connected & disconnected without the operator needing to leave the cab.

Supplied complete with hoses, quick couplings and electrical equipment for one machine.

Advantages:

- » The EC-Oil automatic quick hitch system connects the tiltrotator & hydraulic tools without the operator needing to leave the cab**
- » Q-Safe quick hitch for maximum safety
- » Comes ready for detachable gripper GRD
- » Comes ready for sweeper SWD
- » Comes ready for the QSC locking system to avoid wrongly connected or dropped buckets
- » Comes ready for a rotation sensor (ePS) for connection to the excavator guidance system
- » Central lubrication (a single grease point for the entire tiltrotator; can also be connected to the excavator's central lubrication system)
- » Load-holding valves on tilt cylinders for maximum safety
- » Hardened piston rods
- » Up to ± 45 -degree tilt angle for best access
- » Rotation ∞

Quick hitch: Standard – S45 or S60.

Control system: Standard – DC2 proportional control system for infinitely variable control with remote support capability, track/wheel steering and boom slew. For other purposes, we can deliver custom control systems.

Electrical system: Can be adapted for 12 or 24 volt electrical systems.

Accessory: GRD detachable gripper*, SWD sweeper*.

* Read more about the GRD at engcon.com

** Read more about the terms and conditions concerning the EC-Oil automatic quick hitch system as a free standard at engcon.com



Specifications

Type	EC214
Width A: (mm)*	355
Width B: (mm)*	285
Width C: (mm)*	303
Length overall D: (mm)*	665
Construction height E: (mm)*	from 457
Weight: (kg)*	385
Tilt:	2 x 45°
Rec. hydraulic flow DC2/SS10 (l/min):	80
Rec. hydraulic flow SS9 tilt/rotation: (l/min):	35/50
Max hydraulic pressure: (MPa)	22
Quick hitch standard:	S45, S60
Max bucket width rec. by Engcon: (mm)	1,600
Max breakout torque: (kNm)	126
Base machine weight: (t)	9–14

*Standard attachment

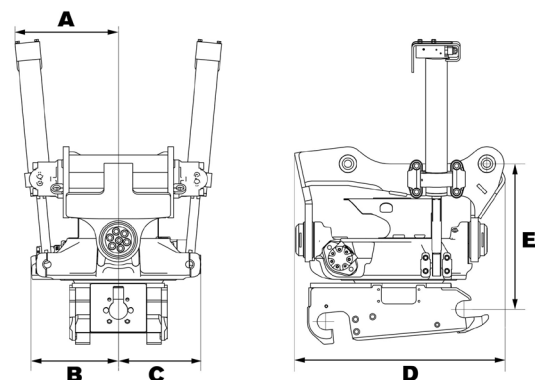

CHANGE THE WORLD OF DIGGING