

Tiltrotator EC02

Suitable for all excavators in the 1.5–3.5 tonne weight class

The tiltrotator: One of the market's smallest tiltrotator's for really small machines weighing up to 3.5 tonnes. With a basic weight of 77 kg, the EC02 has a minimal impact on stability while delivering access and flexibility that only a tiltrotator can provide.

- » Rotation ∞
- » $\pm 40^\circ$ tilt
- » Complies with European safety standards
- » A load-holding valve as standard equipment provides maximum safety

Quick hitch: We offer most types of hitches available on the market.

Control system: Choose between several different control systems based on your machine's characteristics. The EC02 can usefully be fitted with Engcon's DC2 proportional control system for infinitely variable high precision control and remote support via the cell phone network.

Electrical system: Standard 12 volt.

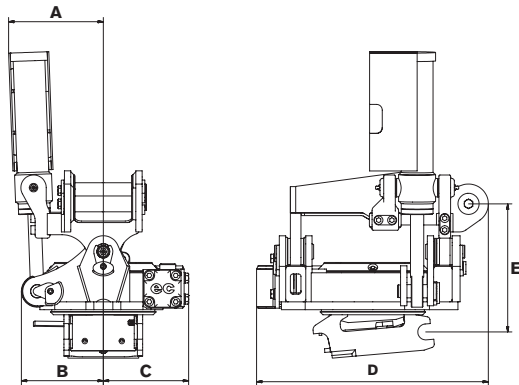

Specifications

Type	EC02
Width A: (mm)*	180
Width B: (mm)*	155
Width C: (mm)*	160
Length overall D: (mm)*	435
Construction height E: (mm)*	from 245
Weight: (kg)*	77
Tilt:	2x40°
Rec. hydraulic flow DC2/SS10 (l/min):	25
Rec. hydraulic flow SS9 tilt/rotation: (l/min):	7/20
Max hydraulic pressure: (MPa)	22
Quick hitch standard:	S30
Max bucket width rec. by engcon: (mm)	900
Max breakout torque: (kNm)	20
Base machine weight: (t)	1.5–3.5

*Standard attachment

CHANGE THE WORLD OF DIGGING