

Tiltrotator EC226

For 41,900–57,300 lbs excavators (19–26 metric ton)

A powerful tiltrotator with low weight and height for excavators up to 57,300 lbs. If EC226 is selected with engcon's standard Quick Coupler S70 and the DC2 proportional control system, EC-Oil automatic Quick Coupler system is offered as a free standard.** This means that the tiltrotator and hydraulic tools can be connected & disconnected without the operator needing to leave the cab.

Supplied complete with hoses, quick couplings and electrical equipment for one machine.

Features:

- » The EC-Oil automatic Quick Coupler system connects the tiltrotator & hydraulic tools without the operator needing to leave the cab**
- » Q-Safe quick coupler for maximum safety
- » Comes ready for the QSC locking system to avoid improperly connected or dropped buckets
- » Comes ready for a rotation sensor (ePS) for connection to the excavator guidance system
- » Central lubrication (a single grease point for the entire tiltrotator; can also be connected to the excavator's central lubrication system)
- » Load-holding valves on tilt cylinders for maximum safety
- » Hardened piston rods
- » Up to ± 45 -degree tilt angle for best access
- » Rotation ∞

Quick coupler: S70 comes standard.

Control system: DC2 comes standard. This proportional control system provides outstanding variable control with remote support capability, track/wheel steering, and boom slew. We also offer custom control systems.

Electrical system: Can be adapted to 12V or 24V.

Accessory: Integrated grabber, GRD detachable grab cassette*

* Read more about GRD at engcon.com

** Read more about the terms and conditions regarding EC-Oil automatic Quick Coupler system as a free standard at engcon.com



Specifications

Model	EC226
Width A (inches)*:	16.8
Width B (inches)*:	13.4
Width C (inches)*:	13.4
Total length D (inches)*:	29.9
Construction height E (inches)*:	from 19.7
Weight (lbs)*:	1,761
Tilt range:	2x45°
Rec. hydraulic flow DC2 & SS10 (gpm):	31.7
Rec. hydraulic flow SS9 tilt/rotation (gpm):	18.5/18.5
Max hydraulic pressure (psi):	3,200
Standard mountings:	S70
Max bucket width rec. by engcon (inches):	78.7
Max torque (lbf):	199,142
Base machine weight min/max (lbs):	41,900–57,300

*Standard attachment

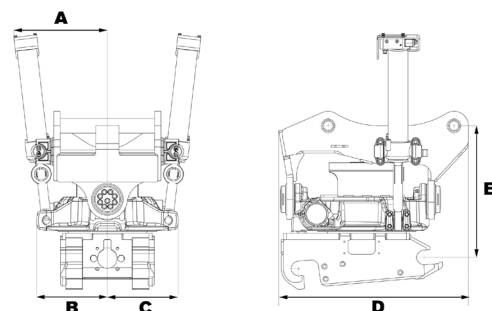

CHANGE THE WORLD OF DIGGING