

Tiltrotator EC226

Suitable for all excavators in the 19–26 tonne weight class

A powerful tiltrotator with low weight and height for excavators up to 26 tons. If the EC226 is selected with engcon's standard quick hitch S70 and the DC2 proportional control system, EC-Oil is offered an automatic quick hitch system as a free standard** This means that the tiltrotator and hydraulic tools can be connected & disconnected without the operator needing to leave the cab.

Comes supplied with hose, quick couplings and electrical installation equipment for one machine.

Advantages:

- » The EC-Oil automatic quick hitch system connects the tiltrotator & hydraulic tools without the operator needing to leave the cab**
- » Q-Safe quick hitch for maximum safety
- » Comes ready for the QSC locking system to avoid wrongly connected or dropped buckets
- » Comes ready for a rotation sensor (ePS) for connection to the excavator guidance system
- » Central lubrication (a single grease point for the entire tiltrotator; can also be connected to the excavator's central lubrication system)
- » Load-holding valves on tilt cylinders for maximum safety
- » Hardened piston rods
- » Up to ± 45 -degree tilt angle for best access
- » Rotation ∞

Quick hitch: Standard – S70.

Control system: Standard – DC2 proportional control system for infinitely variable control with remote support capability, track/wheel steering and boom slew. For other purposes, we can deliver custom control systems.

Electrical system: Can be adapted for 12 or 24 volt electrical systems.

Accessory: Integrated gripper, GRD detachable gripper cassette*

* Read more about the GRD at engcon.com

** Read more about the terms and conditions concerning the EC-Oil automatic quick hitch system as a free standard at engcon.com



Specifications

Type	EC226
Width A: (mm)*	426
Width B: (mm)*	340
Width C: (mm)*	340
Length overall D: (mm)*	760
Construction height E: (mm)*	from 500
Weight: (kg)*	799
Tilt:	2x45°
Rec. hydraulic flow DC2/SS10 (l/min):	120
Rec. hydraulic flow SS9 tilt/rotation: (l/min):	70/70
Max hydraulic pressure: (MPa)	22
Quick hitch standard:	S70
Max bucket width rec. by Engcon: (mm)	2,000
Max breakout torque: (kNm)	270
Base machine weight: (t)	19–26

*Standard attachment

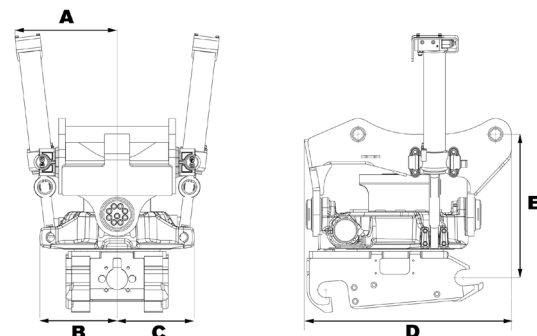

CHANGE THE WORLD OF DIGGING